

SoundScapes® Optra Capz

1. GENERAL

1.1 Product Description

Optra Capz products referenced in these instructions are made from Glass Wool. Optra Capz panels are demountable, or 100% downward accessible. Panels are designed to be attached to a conventional 24mm wide T-bar suspension system. All panels can be removed and re-installed without tools or special equipment for access to the plenum. Optra Capz panels are available in two standard sizes: 1200x1200 and 2400x1200mm (Nom).

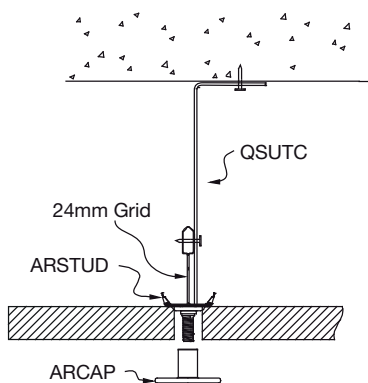

Optra Capz panels have Reverse Tegular edges. Panels are pre-drilled to accept hardware caps. Hardware caps attach to threaded studs which clip onto the suspension system. Unlike many conventional lay-in ceiling products, the Optra Capz edge detail does not lay into the suspension system.

1.2 Surface Finish

The face and edges of Optra Capz panels feature a white painted durable, acoustically transparent scrim finish. The surface of the panel is highly light reflectant and washable.

For minor surface or edge scratches on Optra Capz, use Armstrong SuperCoat™ Touch-up Paint Item #5761. Touch-up recommendations are provided later in this document (Section 6.7). SuperCoat Touch-up Paint data page is CS-3943.

1.3 Storage and Handling

The ceiling panels shall be stored in a dry interior location and shall remain in cartons prior to installation to avoid damage. The cartons shall be stored in a flat position. Proper care should be taken when handling to avoid damage or soiling.

NOTE: Optra Capz panels feature exposed edges. Exercise appropriate care to avoid unnecessary contact or damage to the panel edges. Remember that the grid flanges will not conceal panel edge damage.

1.3.1 Working With Glass Wool & Mineral Fiber Products

GLASS WOOL CEILINGS

1.3.2 Precautionary Measures

During the installation be certain that the work site is well ventilated and avoid breathing dust. If high dust levels are anticipated during installation such as with the use of power tools, use appropriate NIOSH designated dust respirator. All power cutting tools must be equipped with dust collectors. Avoid contact with skin or eyes. Wear long-sleeved, loose-fitting clothes, gloves and eye protection.

1.3.3 First Aid Measures

If contact occurs flush eyes and skin irritation with plenty of water for at least 15 minutes and remove contaminated clothing. After installing material, wash with warm water and mild soap. Wash work clothes separately from other clothing. Rinse washer thoroughly. Refer to Armstrong MSDS (which includes information on established occupational exposure limits) which are available from Armstrong or your employer.

1.4 Site Conditions

Building areas to receive ceilings shall be free of construction dust and debris. These products are not recommended for exterior applications or where standing water is present or where moisture will come in direct contact with the ceiling.

1.5 Plenum

Installation of the Optra Capz system can be directly fixed to the structure. In such installations, design limitations may require a clear plenum and are not suitable for plenum spaces crowded with services or obstructions..

1.6 Fire Sprinklers

Optra Capz panels, as with other architectural features located at the ceiling, may obstruct or skew the planned fire sprinkler water distribution pattern, or possibly delay or accelerate the activation of the sprinkler or fire detection systems by channeling heat from a fire either toward or away from the device. Please consult a fire protection engineer and the local codes for guidance where automatic fire detection and suppression systems are present.

2. COMPONENTS

2.1 Grid

Optra Capz installations use standard Prelude 24mm T-bar grid. Grid can be attached directly to the structure with rigid connectors or suspended with 2.5mm hanger wire or 5mm rod.

2.2. Capz System Connectors

2.2.1. QSUTC is a rigid attachment clip to fasten the grid to structure.

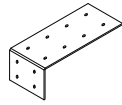

2.2.3. ARSTUD (6.35mm threads x 20mm long) is used to secure the Optra Capz panel to the grid. The ARSTUD snaps onto the 24mm Prelude T-bar grid at the required locations. Pre-drilled ceiling panels fit onto the ARSTUD.

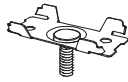

2.2.4. ARCAP screws through the panel onto the ARSTUD to align and support the panel. Caps are available in white, silver and black. Caps screw onto the ARSTUD stud and have a 30mm diameter face to support the panel.

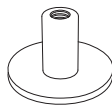

2.2.5. ARPLUG locks the cross tee tabs into the slot along the outside row of main beams of Optra Capz installations. NOTE: ARPLUGs only work with Armstrong XL cross tee end details.

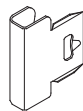

2.2.6. Panels

Optra Capz 30mm panels are available in standard nominal sizes including: 1200x1200 and 1200x2400mm (Nom). Panel edges are square for a clean smooth visual when installed. Panels are pre-drilled with a 12.5mm hole that easily fits over the ARSTUD.

3. REFLECTED CEILING PLAN

Refer to the reflected ceiling plan to determine the proper grid layout. Optra Capz panels require grid above all pre-drilled holes in the panels.

3.1 Grid Layout

Grid layout uses standard main beams and cross tees. Main beams usually run the long direction of the installation. On-center spacing will be determined by the panel configuration. Cross tee length and spacing is also determined by the panel configuration. See grid layout example on page 5.

4. CAPZ GRID INSTALLATION

Optra Capz suspension grid is attached directly to the structure with rigid brackets or by typical suspension rod/wire.

4.1 Grid Layout

Grid layout is very important for ease of panel fit, alignment and best visual. Refer to the reflected ceiling plan to determine the correct grid components and on-center spacing.

4.2 Brackets

Brackets are used to attach the main beam to structure. Brackets are recommended within 305mm of the ends and not more than 1220mm on center along the run of main

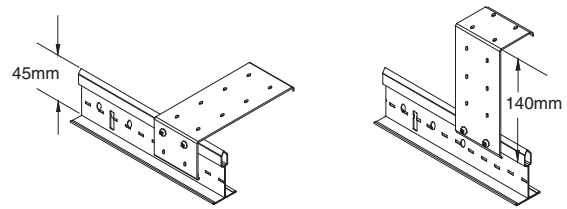

beams. Brackets allow grid elevation adjustment from 45mm to 140mm. Use heavy snips or a hacksaw to trim the bracket for different heights or as needed to level the grid. Avoid installing bracket on the main beam at the location of cross tees.

4.2.1 QSUTC – This clip must be accurately located before fastening to the structure for correct grid alignment and proper panel fit. Use a string line or laser to establish a straight row for bracket attachment. Use the appropriate fastener to anchor the clip to the structure.

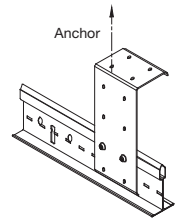

4.2.2 Hanger Wire – 2.5mm hanger wire on 5mm rod can be used for Optra Capz systems when the grid will be installed more than 140mm below the structure. This suspended grid system must be installed to meet AS/NZS 2785:2000 standards and International Building Code seismic installations as required by local authority.

4.3 Install Grid

The grid must be installed straight, level and square for best panel fit and alignment. Optra Capz panels require grid above all the pre-drilled mounting holes. It's best to have two holes per panel at a main beam/cross tee intersection to keep the panel in place but not required. Some Optra Capz layout designs may have only every other panel with holes at a main beam/cross tee intersection. Optra Capz panels cover or conceal most of the grid. Hangers and grid may be in the line of sight when installed at lower elevations.

4.3.1 Main Beams – Mains must be attached to the bracket so that a cross tee slot is located at the hole locations of the panel per the reflected ceiling plan. Optra Capz panels extend 152mm past the mounting hole. Trim off the main beam end approximately 76mm past the first and last cross tee location to keep the main beam concealed.

4.3.1.1 First Row of Main Beams – Use clamps or vise grips to temporarily secure the first main to the brackets. Adjust for proper location and elevation. Use two sheet metal screws (Type #8 x 1/2 sharp point screw) to fasten the bracket to the main beam. Use the typical method to join sections of main beams for long runs.

4.3.1.2 Additional Rows of Main Beams – Brackets should be installed accurately for the proper main beam spacing as per the reflected ceiling plan. Use clamps or vise grips to temporarily secure the second main to the brackets. Check for the correct on-center spacing for the cross tee; adjust if necessary. Install two cross tees at the proper location.

CHECK SYSTEM SQUARENESS – this is a critical stage of grid installation. System squareness must be within 1.6mm. The system must be square or will result in improper panel fit, poor alignment, and an unacceptable visual. Measure diagonals, use a carpenter's square or the 3-4-5 method to

square the system. Secure the second main beam to the brackets with sheet metal screws. Install additional main beams keeping the system straight and square.

4.3.2 Cross Tees – Refer to the reflected ceiling plan to determine the length and on-center spacing of the cross tees. Install the cross tees as required. Since the mains are secured with rigid brackets, you may need to roll the top bulb away to ease insertion of the cross tee clip.

4.3.2.1 ARPLUG – All the cross tees along the outside rows of main beams will have a single tab inserted into the cross tee slot. To secure and align this tab, insert the ARPLUG along the right side of the cross tee tab.

NOTE: ARPLUGs only work with Armstrong XL® cross tee end details. See ARPLUG detail in drawing on page 6.

5. INSTALL ARSTUD

Refer to the reflected ceiling plan for panel hole or stud locations. Optra Capz panels may have all studs at a main beam/cross tee intersection, a combination of studs at main beam/cross tee intersections and studs along the grid flange or on the grid flange only. ARSTUDs easily snap onto the grid flange. Make sure all four corner tabs lock onto the grid.

5.1 Grid Intersections

The ARSTUD fits over grid intersections and will secure the Optra Capz panel for proper stud spacing and panel alignment.

5.2 Grid Flange

The ARSTUD fits anywhere along the grid flange as needed. Standard Optra Capz panel stud locations are on 305mm increments. Snap the ARSTUD onto the grid and slide it directly under a cross tee slot at the required spacing.

6. PANEL INSTALLATION AND CAPS

6.1 Panel Orientation

Install all Optra Capz panels with the directional arrow in the same direction to provide installation consistency, uniform visual and proper panel alignment. Align panels as you proceed to ensure a uniform 6.4mm reveal width between panels. Minor variations in panel placement can be difficult to see from a scaffold, but will become obvious when looking down long runs of panels. See detail in drawing on page 6.

6.2 Large Panels

The use of two installers is recommended for Optra Capz panels exceeding 1830mm. Having two installers for all Optra Capz panel installations will ease the installation, minimize exposed edge damage, and help maintain proper panel alignment.

6.3 Panel Installation

Handle with clean hands and use care to avoid soiling or damage.

- Step 1:** Gently raise the Optra Capz panel up until the 12.7mm diameter holes fit over the 6.4mm ARSTUDs
- Step 2:** While holding the panel up against the grid, partially thread 2 or 3 caps onto the stud to support the panel
- Step 3:** Insert all caps completely onto the stud finger tight

Step 4: Install remaining panels

- Align panels for uniform reveal
- Adjust minor corner elevations with threaded cap

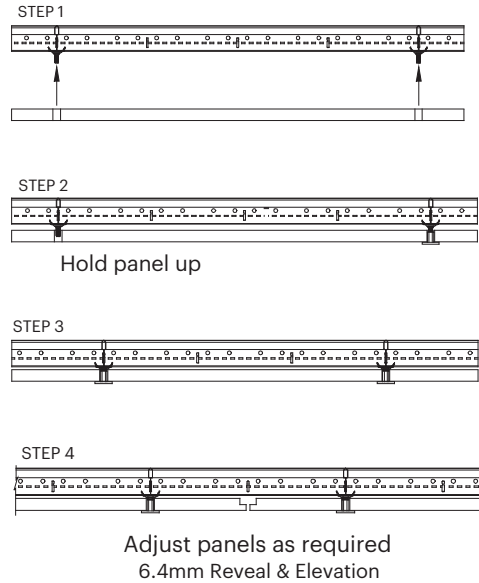

6.4 Panel Removal

- Step 1:** Loosen 2 or 3 caps that support the panel
- Step 2:** Remove the remaining cap
- Step 3:** While supporting the panel, remove all the caps
- Step 4:** Gently lower the panel down off the studs

6.5. Ceiling Penetrations

Optra Capz panel installations will generally be full-size panels and will not usually cover the entire area wall to wall. Optra Capz panels should not be installed in areas with major plenum services or obstructions that must pass through the panels. Some plenum penetrations may require not installing an Optra Capz panel in the desired location, leaving that space open. However the following guidelines will help when something must penetrate an Optra Capz panel:

6.5.1 Penetration Through the Panel – When the Optra Capz panel can be installed over the penetration – example: fire sprinkler, independent light cable, mounting bracket for AV equipment – cut a clearance hole in the panel at the correct location and install as usual.

Options for hole edge treatment are:

- Option 1:** Use the appropriate escutcheon or trim ring to cover the cut hole.
- Option 2:** Cut the clearance hole 25mm larger on all sides and field paint the cut edge

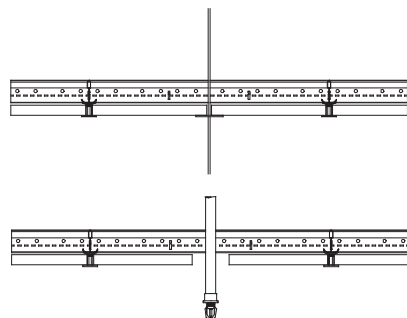

6.5.2 Notched Panel for Penetration – If the obstruction or penetration prevents the panel from fitting over it, you will need to notch the panel to fit around the penetration; e.g., structural brace, roof drain line, hangers for other services.

Step 1: Mark the penetration on the face of the Optra Capz panel

Step 2: Cut the notch or the corner off to provide 25mm to 50mm clearance around the penetration for ease of installation

Step 3: Provide additional panel support if you cut off a mounting hole. (See section 6.6.1. for details)

Step 4: Field paint the exposed edges

Step 5: Install panel

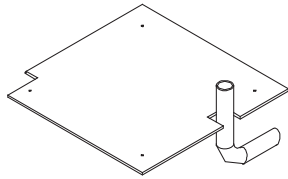

6.6 Field Cut Edges

Optra Capz panel installation should be designed for full panels and no cut borders, however, you may need to field cut a panel in some installations

6.6.1. Additional Panel Support is required whenever a panel mounting hole is trimmed off. This requires field drilling a new mounting hole and installing extra grid to relocate the ARSTUD.

Step 1: Field cut the panel as required to fit

Step 2: Relocate or install an extra cross tee within 152mm of the trimmed edge or corner

Step 3: Install an ARSTUD on the grid to support the panel

Step 4: Measure the location of the new stud and transfer it to the trimmed panel. Drill a 13mm hole at this location

Step 5: Field paint the cut edges and install the panel and caps as usual

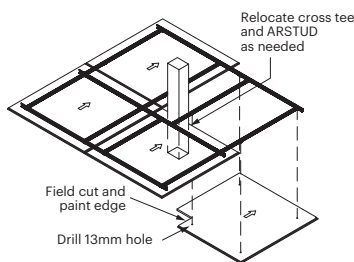

7. CUTTING & FINISHING PANELS

It is not recommended to cut and refinish panels on site.

Special sizes may be ordered to suit project requirements.

If panels must be cut, follow points 1-3 below

1. Apply Bond Crete to seal the exposed cut ends of the Baffles and allow to dry
2. If required it may need a light sand with a fine sandpaper to remove any exposed fibres
3. Apply touch up paint to the newly cut and sealed Baffle ends

8. CLEANING

Use a clean, dry, soft white cloth to wipe off any dirt or finger prints. Regular light dusting of the top side of the Baffle is recommended.

9. LIGHTS AND FIXTURES

Lights and fixtures that mount in OPTRA Capz panels may require additional suspension grid for support; e.g., speakers, can lights, life safety alarms or sensors.

Additional cross tees can be installed in the grid as necessary to mount and support other fixtures. Fixtures exceeding 20 pounds may require extra grid support.

10. SLOPED INSTALLATIONS

OPTRA Capz panels can be installed on a slope using the following guidelines:

- All main beams must be installed running up and down the slope
- Mains must be attached using the QSUTC rigid clip
- All panels must have one edge with studs/caps securely attached to the grid to prevent them from sliding down the slope. This can be done by installing extra cross tees between mains or by screw attaching the stud to the grid. See detail in Section 9.
- All sloped installations must be approved by local authorities at plan review

11. SEISMIC INSTALLATIONS

The following recommendations are for installations in areas of severe seismic activity and Seismic Design Category D, E and F:

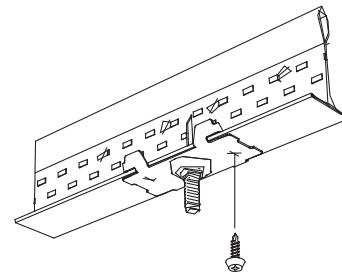

- Use QSUTC for rigid grid attachment to structure
- ARSTUD must be installed at a grid intersection OR screw attached to the grid
- All single cross tee insertions must use the ARPLUG to lock the cross tee to the outside main beam

Configuration Drawings and Components

Three Panels – 1200 x 1200 Panel Layout

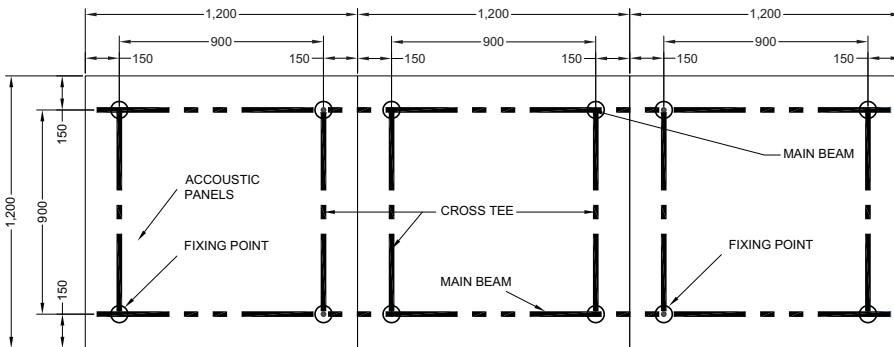

| Description | Item No. |
|--------------------------------|-----------|
| Optra Panels | |
| 1200 x 1200 x 30mm Square edge | OC3932 |
| Grid Components | |
| Prelude Main Beam | BP734042P |
| Plrelude 900 Cross Tee | BP311852P |
| Hardware Components | |
| Rigid Attachment Clip | QSUTC |
| Threaded Stud | ARSTUD |
| Cap | ARCAP |
| Cross Tee Plug Clip | ARPLUG |

Six Panels – 1200 x 1200 Panel Layout

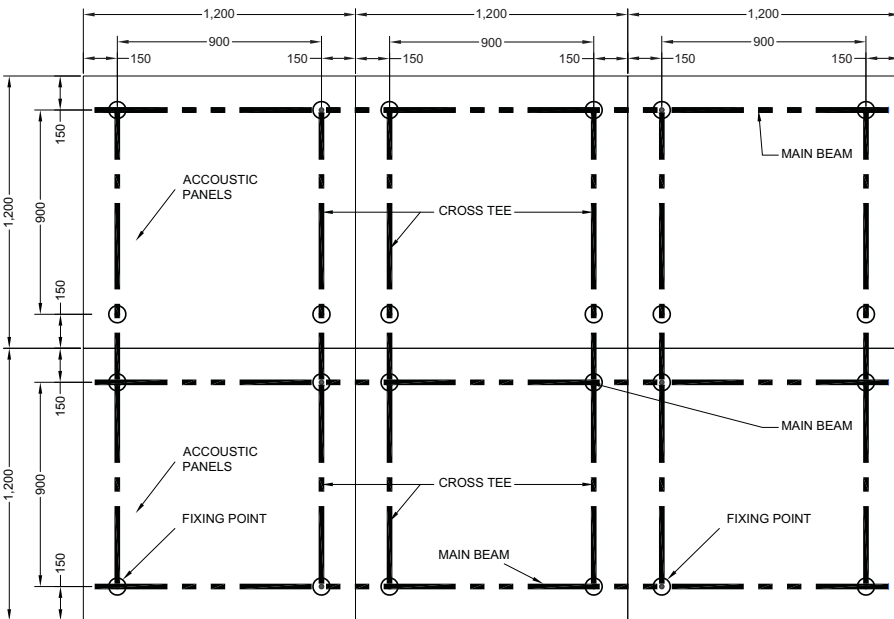

| Description | Item No. |
|--------------------------------|-----------|
| Optra Panels | |
| 1200 x 1200 x 30mm Square edge | OC3932 |
| Grid Components | |
| Prelude Main Beam | BP734042P |
| Prelude 1200 Cross Tee | BP313052P |
| Plrelude 900 Cross Tee | BP311852P |
| Hardware Components | |
| Rigid Attachment Clip | QSUTC |
| Threaded Stud | ARSTUD |
| Cap | ARCAP |
| Cross Tee Plug Clip | ARPLUG |

Two Panels – 2400 x 1200 Panel Layout

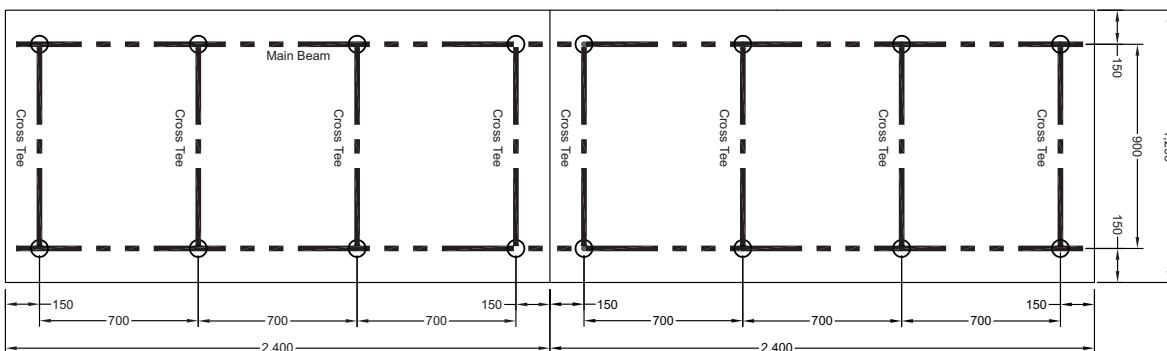

Two Panels – 2400 x 1200 Panel Layout

| Description | Item No. |
|--------------------------------|-----------|
| Optra Panels | |
| 2400 x 1200 x 30mm Square edge | OC3933 |
| Grid Components | |
| Prelude Main Beam | BP734042P |
| Prelude 900 Cross Tee | BP311852P |
| Hardware Components | |
| Rigid Attachment Clip | QSUTC |
| Threaded Stud | ARSTUD |
| Cap | ARCAP |
| Cross Tee Plug Clip | ARPLUG |

Four Panels – 2400 x 1200 Panel Layout

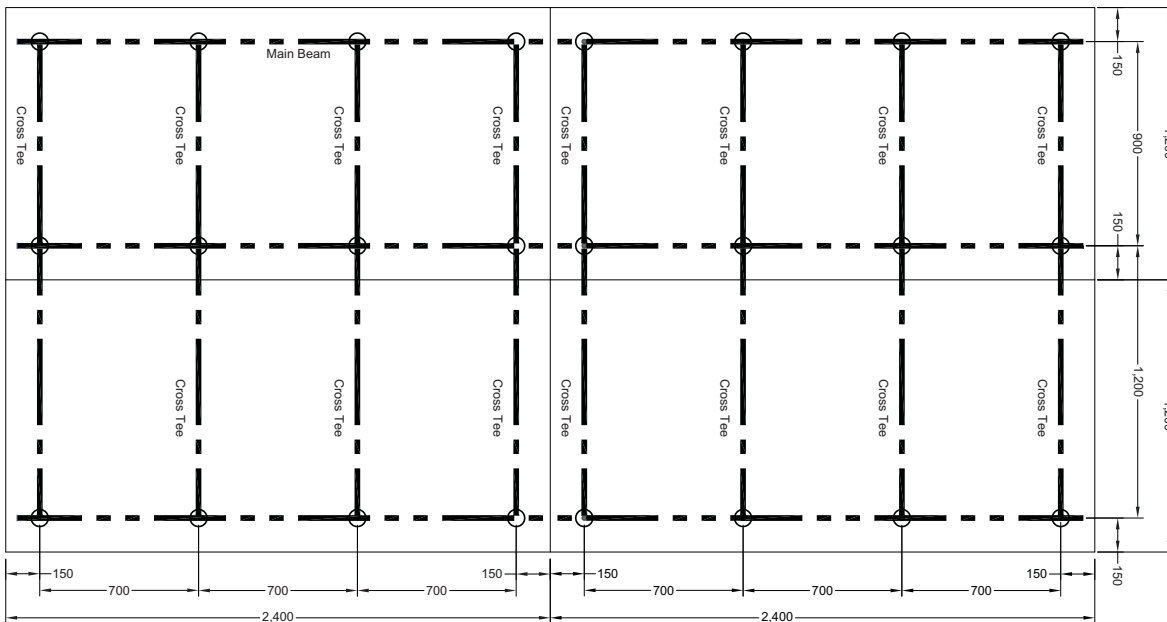

| Description | Item No. |
|--------------------------------|-----------|
| Optra Panels | |
| 2400 x 1200 x 30mm Square edge | OC3933 |
| Grid Components | |
| Prelude Main Beam | BP734042P |
| Prelude 1200 Cross Tee | BP313052P |
| Prelude 900 Cross Tee | BP311852P |
| Hardware Components | |
| Rigid Attachment Clip | QSUTC |
| Threaded Stud | ARSTUD |
| Cap | ARCAP |
| Cross Tee Plug Clip | ARPLUG |

Optra Capz Ceiling System Assembly

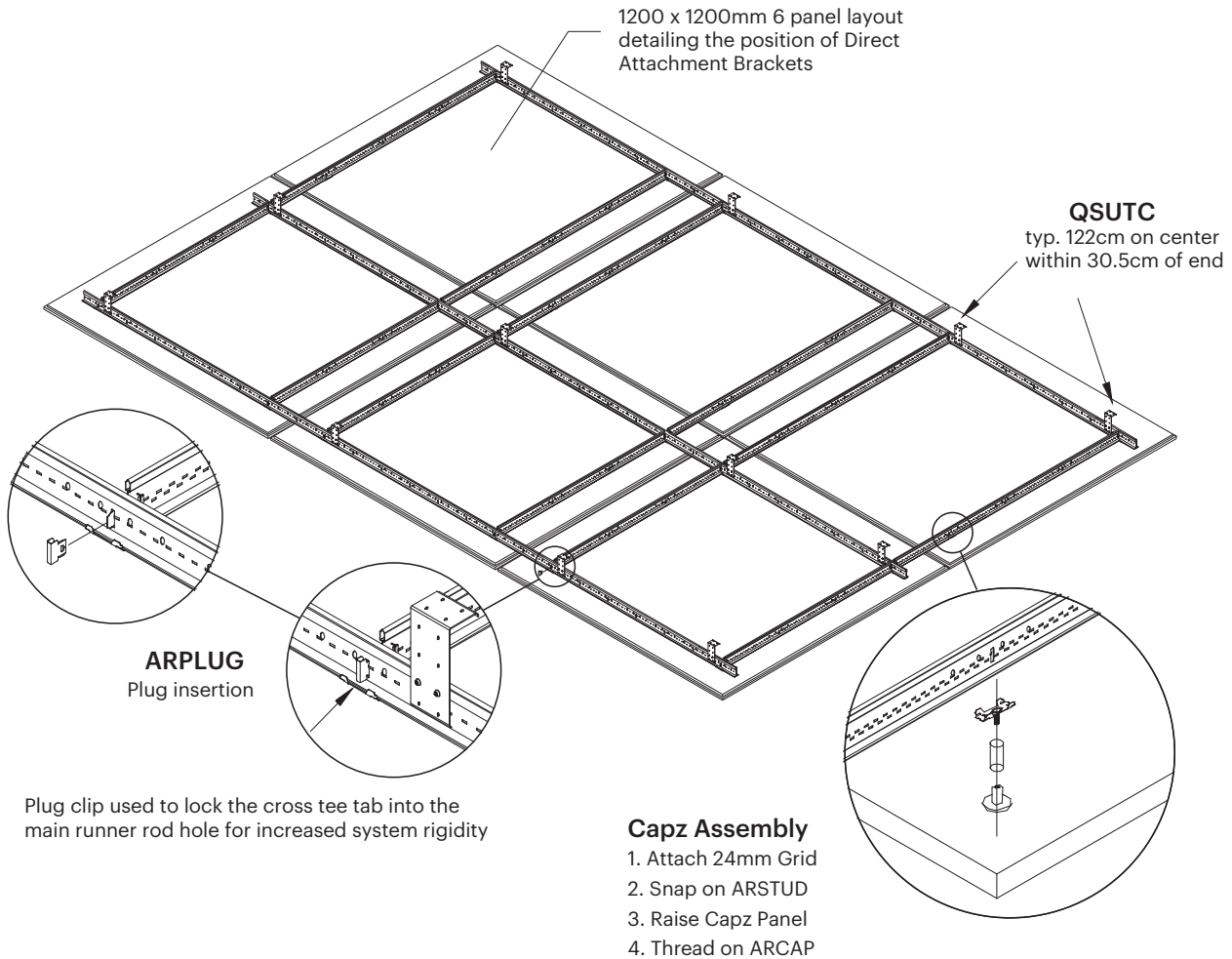

MORE INFORMATION

For complete technical information, detail drawings, CAD design assistance, installation information and many other technical services, call your local Armstrong Ceilings representative.

For the latest product selection and specification data, visit armstrongceilings.com.au

Contact us

NSW/ACT

Armstrong Ceiling Solutions (Australia) Pty. Ltd.
Unit 4, 1 Basalt Road, Pemulwuy NSW 2145
Telephone (02) 9748 1588

VIC/TAS

Armstrong Ceiling Solutions (Australia) Pty. Ltd.
Unit 1, 88 Henderson Road, Rowville VIC 3178
Telephone (03) 8706 4000

QLD / NT

Armstrong Ceiling Solutions (Australia) Pty. Ltd.
6 Barrinia Street, Slacks Creek QLD 4127
Telephone (07) 3809 5565

SA

Total Building Systems Pty. Ltd.
160 Grand Junction Road, Blair Athol SA 5084
Telephone (08) 7325 7555

WA

Ceiling Manufacturers of Australia Pty. Ltd.
3 Irvine Street, Bayswater WA 6053
Telephone (08) 9271 0777

New Zealand

Forman Building Systems Ltd.
27B Smales Road, East Tamaki, Auckland 2013
Telephone 64-9-276 4000

Armstrong
CEILING SOLUTIONS